

AVANT

Rotary broom 1150 A1177

Collector box 1150 A1179

Parts list



Manufacturer:

AVANT

AVANT TECNO OY

Ylötie 1

FIN-33470 YLÖJÄRVI

FINLAND

Tel. +358 3 347 8800

Fax. +358 3 348 5511

E-mail sales@avanttecno.com

Web www.avanttecno.com

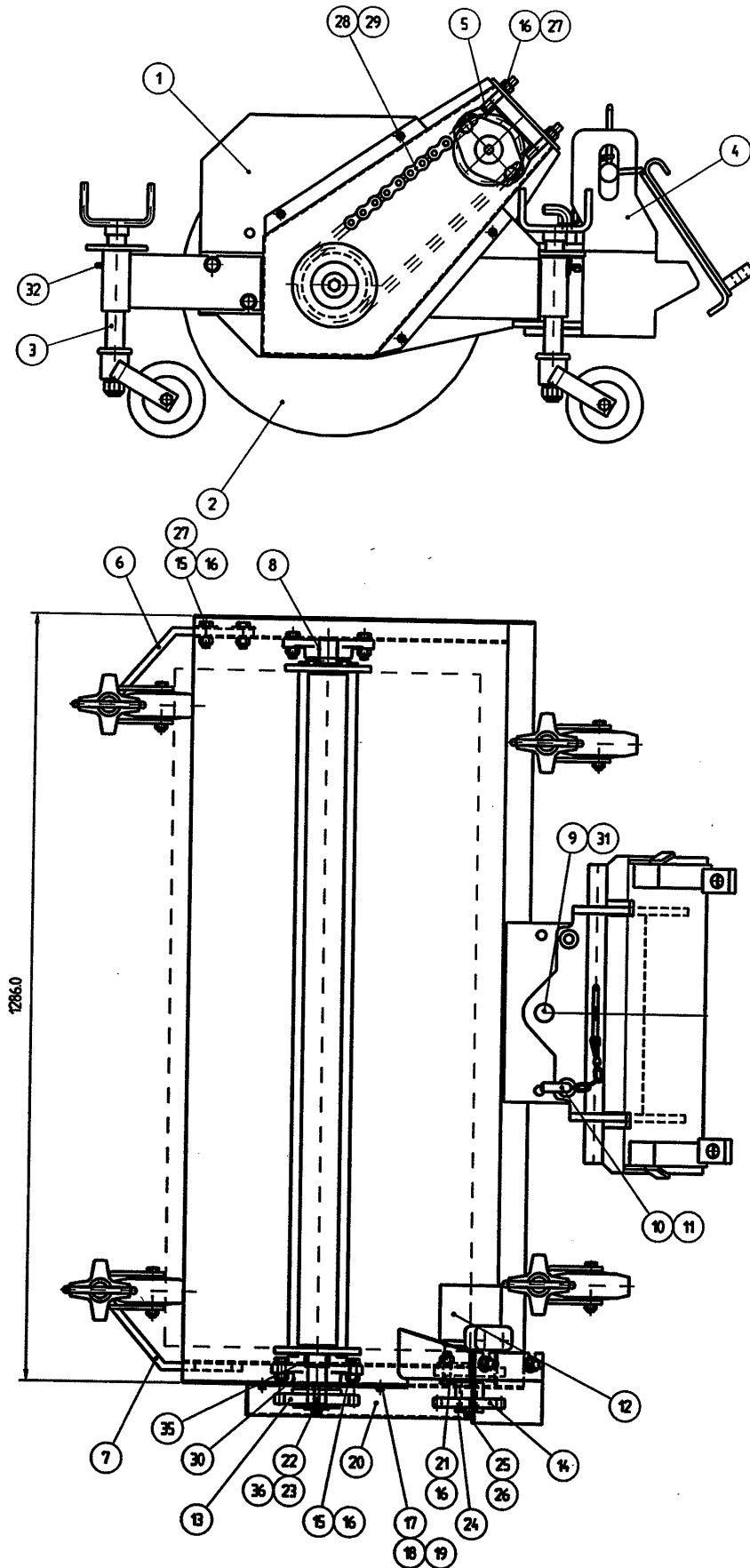

AVANT ROTARY BROOM A1177, GENERAL ASSEMBLY

Pos.	AVANT part no.	Designation	PCS
1	A20128	Frame	1
2	A32476	Shaft, with brush sections	1
3	A45072	Support wheel	4
4	A32717	Mounting bracket, attachment coupl plate	1
5	A45596	Chain tightening device	1
6	A45597	Mounting bracket, right, support wheel	1
7	A45603	Mounting bracket, left, support wheel	1
8	63378	Bearing UCFL 206	2
9	A45074	Pivot pin	1
10	A45073	Adjustment pin	1
11	71725	Ring sprint	1
12	64094	Hydraulic motor SAM AR160 NC25	1
13	A45060	Sprocket, 1", z = 15	1
14	A42510	Sprocket, 1" z = 13	1
15	73042	Hexagonal screw M12*35 DIN 933	8
16	72324	Hexagonal nut M12 DIN 985 NYLOC	12
17	72117	Hexagonal screw M6*16 DIN 933	4
18	72318	Hexagonal nut M6 DIN 985 NYLOC	4
19	74523	Washer M6 6,5*20*1,25	4
20	A32787	Cover plate, chain	1
21	72171	Hexagonal screw M12*45 DIN 931	2
22	72150	Hexagonal screw M10*25 DIN 933	1
23	A45077	Washer	1
24	A45075	Washer	1
25	72132	Hexagonal screw M8*25 DIN 933	1
26	63944	Washer, pair, M8, Nordlock NL8SP	1
27	71691	Washer M12 A13 DIN 125	6
28	63013	Chain, 16B-1 1", 39 links	1
29	73606	Connection link 16B-1 1" straight	1
30	72358	Nipple M6 45 degrees	1
31	71776	Spring cotter 8*50 DIN 1481	2
32	72799	Grease nipple M6 straight	5
33	A32268	Hydraulic hose, l = 2200	1
34	A32269	Hydraulic hose, l = 2100	2
35	A45076	Bushing	1
36	74531	Washer, pair, M10, Nordlock NL10	1

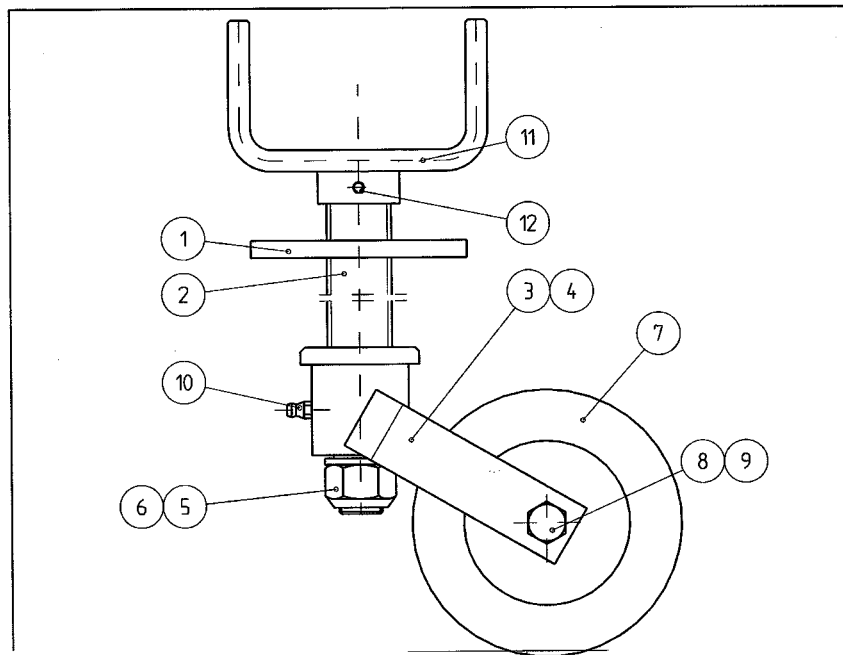
SUPPORT WHEEL A45072, ROTARY BROOM A1177

Pos.	AVANT part no.	Designation	PCS
1		Locking plate	1
2		Axle, threaded	1
3		Yoke, wheel	1
4	64288	Slide bearing GFM-2528-16	2
5	72335	Hexagonal nut M20 DIN 985 Nyloc	1
6	73123	Washer M20, A21 DIN 125	1
7	64139	Wheel Manner LI-125	1
8	74488	Hexagonal screw M10*70 DIN 931 ZN	1
9	72322	Hexagonal nut M10 DIN 985 Nyloc	1
10	72799	Grease nipple M6 straight	1
11		Handle	1
12	71776	Spring cotter M8*50 DIN 1481	1

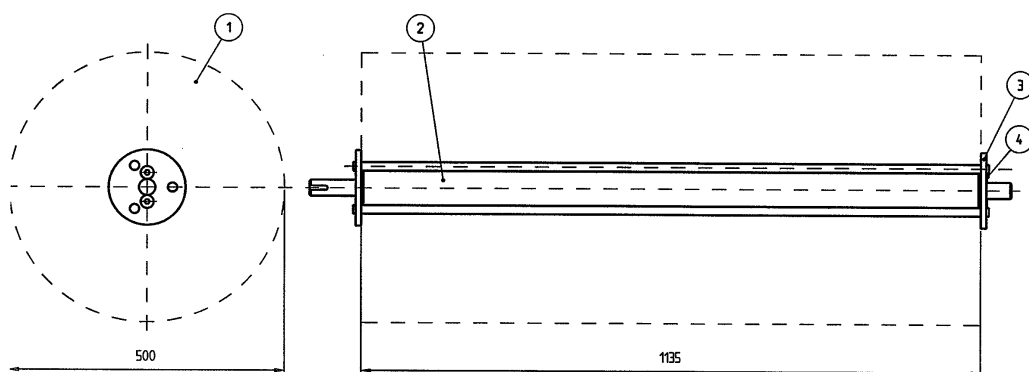
SHAFT WITH BRUSH SECTIONS A32476

Pos.	AVANT part no.	Designation	PCS
1	64660	Brush section F500/F114,3-35	34
2	A32477	Shaft	1
3	A45197	Tightening flange	1
4	73191	Hexagonal slotted head screw M12*35	2

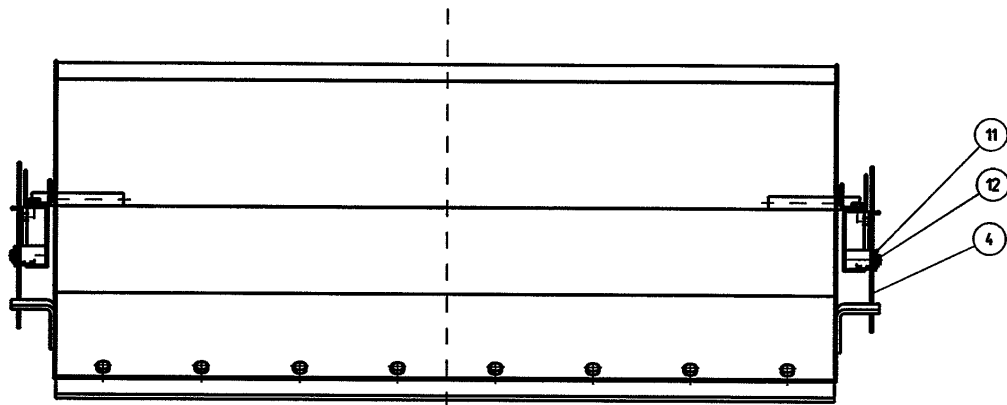
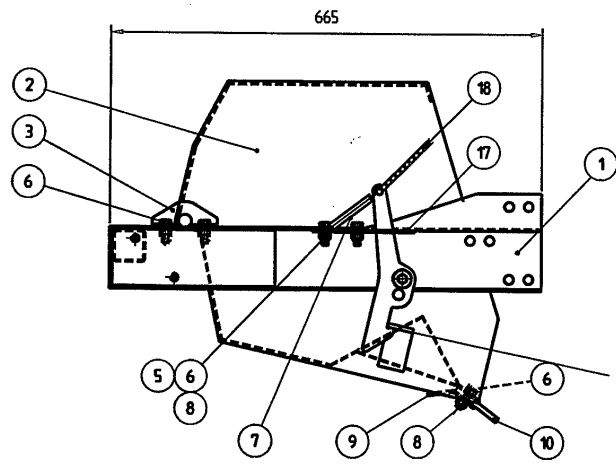

PARTS LIST, COLLECTOR BOX A1179 TO ROTARY BROOM A1177

Pos.	Part no.	Designation	PCS
1	A32282	Frame	1
2	A32281	Collector box	1
3	A44381	Cover, bearings	2
4	A44376	Support hook	2
5	73121	Washer M10	8
6	72151	Hexagonal screw M10* 30	14
7	64257	Retaining spring SF-DF 1,2*12*60 N=33	1
8	72322	Hexagonal nut M10 DIN985 Nyloc	12
9	A32286	Support plate, rubber lip	1
10	A32063	Rubber lip 8	1
11	71685	Washer M8	7
12	72128	Hexagonal screw M8* 12	2
13	A32285	Dust plate	1
14	A32062	Rubber lip 4	1
15	72132	Hexagonal screw M8* 25	5
16	72320	Hexagonal nut M8 DIN985 Nyloc	5
17	A45099	Blocking plate	2
18	64393	Rope F8 mm orange 7 m	1